

CR8AM

MEDIUM POWER USE
NON-INSULATED TYPE, GLASS PASSIVATION TYPE

CR8AM

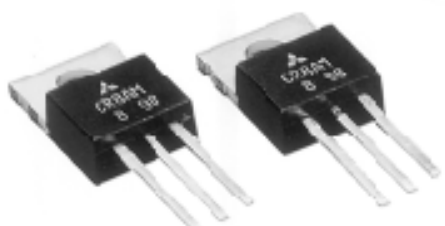

- **IT (AV) 8A**
- **VDRM 400V/600V**
- **IGT 15mA**

OUTLINE DRAWING

Dimensions in mm

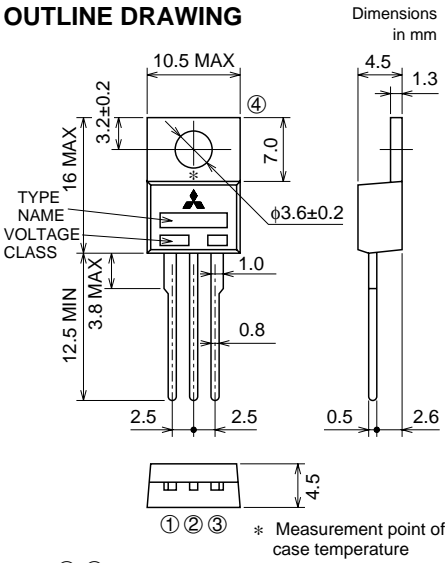

TYPE NAME
VOLTAGE CLASS

① ② ③ * Measurement point of case temperature

① CATHODE
② ANODE
③ GATE
④ ANODE

TO-220

APPLICATION

Switching mode power supply, ECR, regulator for auticycle, motor control

MAXIMUM RATINGS

Symbol	Parameter	Voltage class		Unit
		8	12	
VRRM	Repetitive peak reverse voltage	400	600	V
VRSM	Non-repetitive peak reverse voltage	500	720	V
VR (DC)	DC reverse voltage	320	480	V
VDRM	Repetitive peak off-state voltage	400	600	V
VD (DC)	DC off-state voltage	320	480	V

Symbol	Parameter	Conditions	Ratings	Unit
IT (RMS)	RMS on-state current		12.6	A
IT (AV)	Average on-state current	Commercial frequency, sine half wave, 180° conduction, Tc=88°C	8	A
ITSM	Surge on-state current	60Hz sine half wave 1 full cycle, peak value, non-repetitive	120	A
I ² t	I ² t for fusing	Value corresponding to 1 cycle of half wave 60Hz, surge on-state current	60	A ² s
PGM	Peak gate power dissipation		5	W
PG (AV)	Average gate power dissipation		0.5	W
VFGM	Peak gate forward voltage		6	V
VRGM	Peak gate reverse voltage		10	V
IFGM	Peak gate forward current		2	A
Tj	Junction temperature		-40 ~ +125	°C
Tstg	Storage temperature		-40 ~ +125	°C
—	Weight	Typical value	2.0	g

CR8AM

MEDIUM POWER USE
NON-INSULATED TYPE, GLASS PASSIVATION TYPE

ELECTRICAL CHARACTERISTICS

Symbol	Parameter	Test conditions	Limits			Unit
			Min.	Typ.	Max.	
IRRM	Repetitive peak reverse current	$T_j=125^\circ\text{C}$, V_{RRM} applied	—	—	2.0	mA
IDRM	Repetitive peak off-state current	$T_j=125^\circ\text{C}$, V_{DRM} applied	—	—	2.0	mA
V _{TM}	On-state voltage	$T_c=25^\circ\text{C}$, $I_{TM}=25\text{A}$, instantaneous value	—	—	1.4	V
V _{GT}	Gate trigger voltage	$T_j=25^\circ\text{C}$, $V_D=6\text{V}$, $I_T=1\text{A}$	—	—	1.0	V
V _{GD}	Gate non-trigger voltage	$T_j=125^\circ\text{C}$, $V_D=1/2V_{DRM}$	0.2	—	—	V
I _{GT}	Gate trigger current	$T_j=25^\circ\text{C}$, $V_D=6\text{V}$, $I_T=1\text{A}$	—	—	15	mA
I _H	Holding current	$T_j=25^\circ\text{C}$, $V_D=12\text{V}$	—	15	—	mA
R _{th(j-c)}	Thermal resistance	Junction to case	—	—	3.0	$^\circ\text{C/W}$

*1. The contact thermal resistance R_{th(j-c)} is 1.0 $^\circ\text{C/W}$ with greased.

PERFORMANCE CURVES

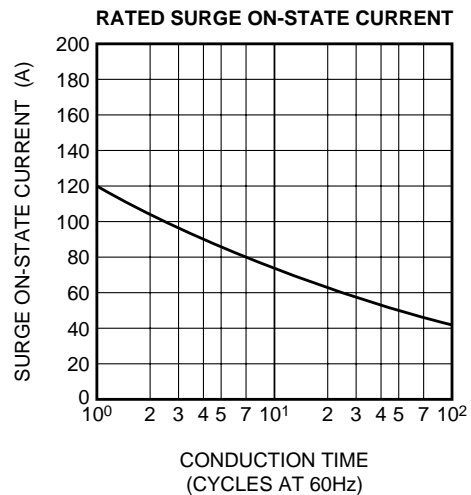
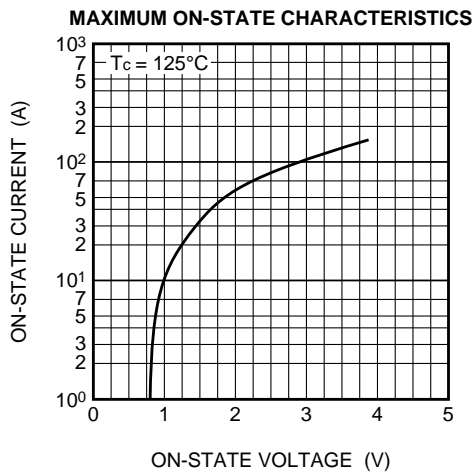

CR8AM

MEDIUM POWER USE

NON-INSULATED TYPE, GLASS PASSIVATION TYPE

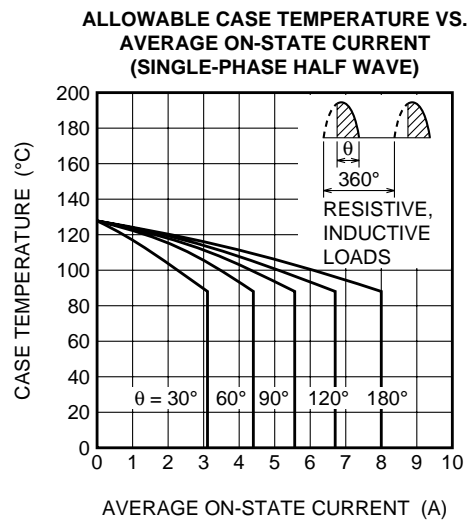
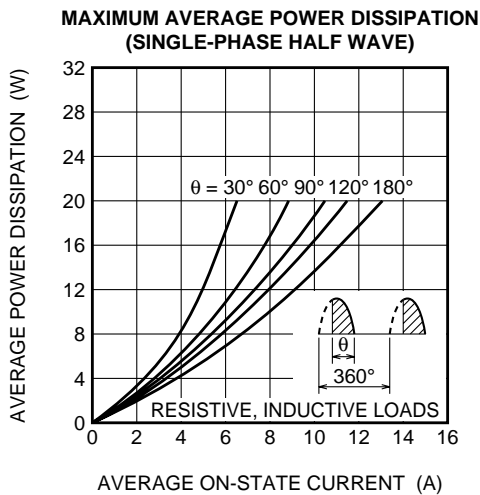
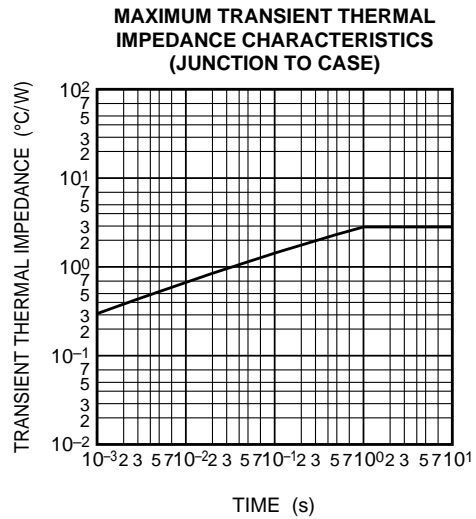
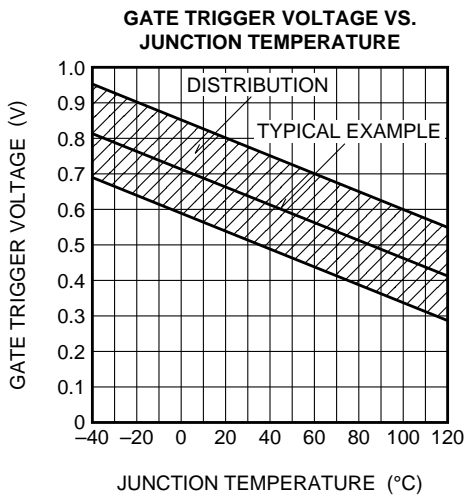
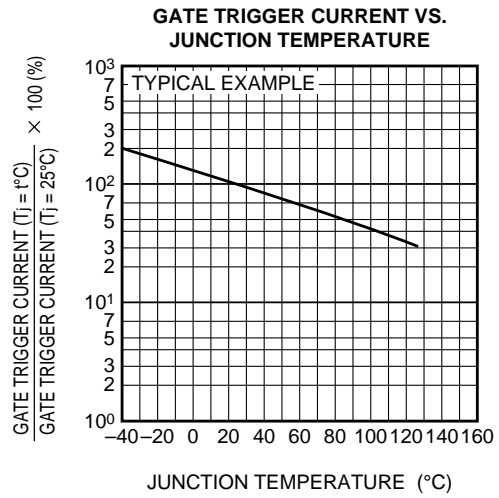
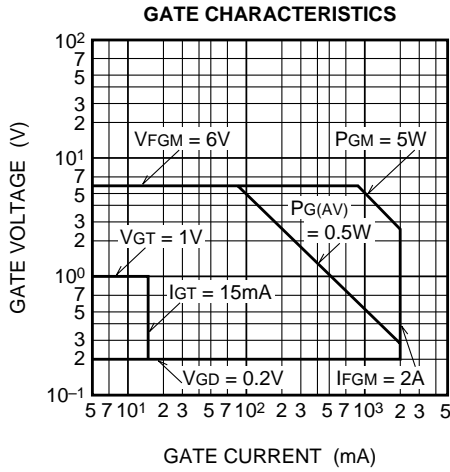

CR8AM

MEDIUM POWER USE

NON-INSULATED TYPE, GLASS PASSIVATION TYPE

**MAXIMUM AVERAGE POWER DISSIPATION
(SINGLE-PHASE FULL WAVE)**

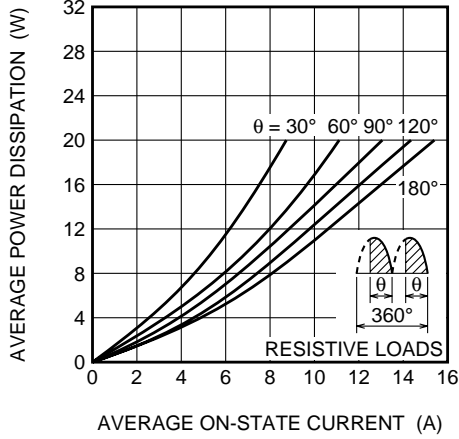

**ALLOWABLE CASE TEMPERATURE VS.
AVERAGE ON-STATE CURRENT
(SINGLE-PHASE FULL WAVE)**

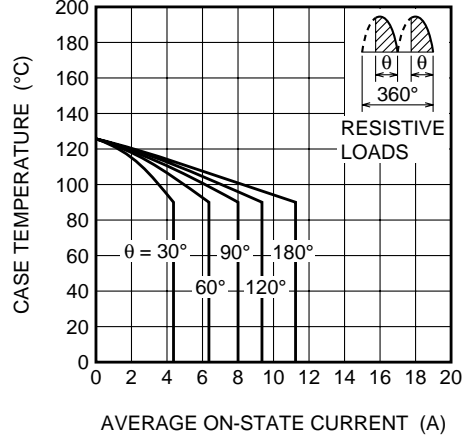

**MAXIMUM AVERAGE POWER DISSIPATION
(RECTANGULAR WAVE)**

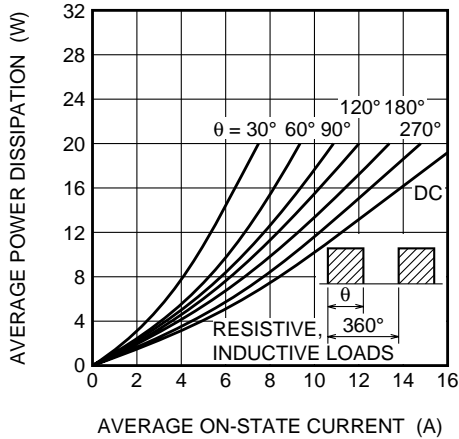

**ALLOWABLE CASE TEMPERATURE VS.
AVERAGE ON-STATE CURRENT
(RECTANGULAR WAVE)**

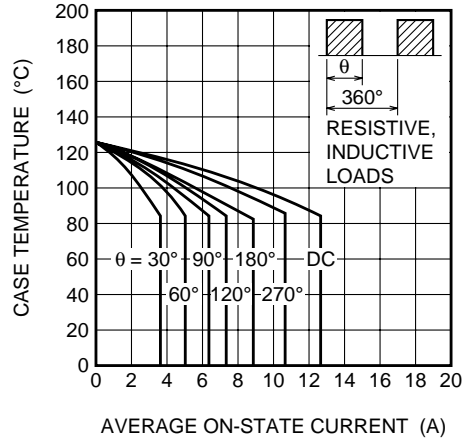

**BREAKOVER VOLTAGE VS.
JUNCTION TEMPERATURE**

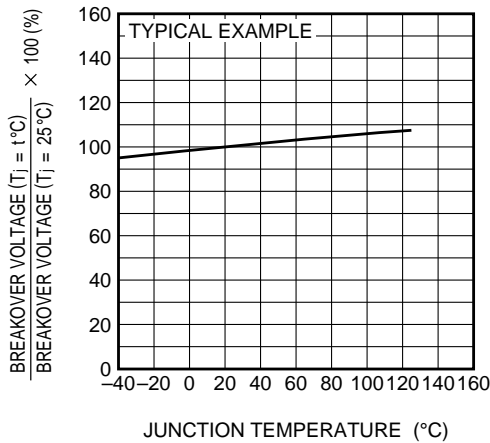

**BREAKOVER VOLTAGE VS.
RATE OF RISE OF OFF-STATE VOLTAGE**

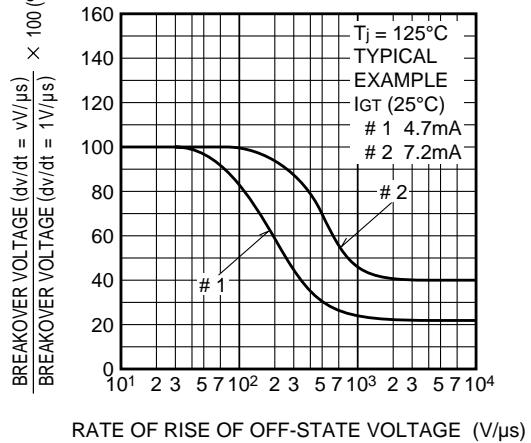

CR8AM

MEDIUM POWER USE

NON-INSULATED TYPE, GLASS PASSIVATION TYPE

HOLDING CURRENT VS. JUNCTION TEMPERATURE

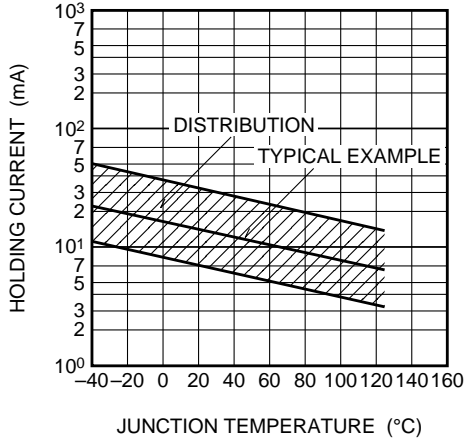

HOLDING CURRENT VS. GATE TRIGGER CURRENT

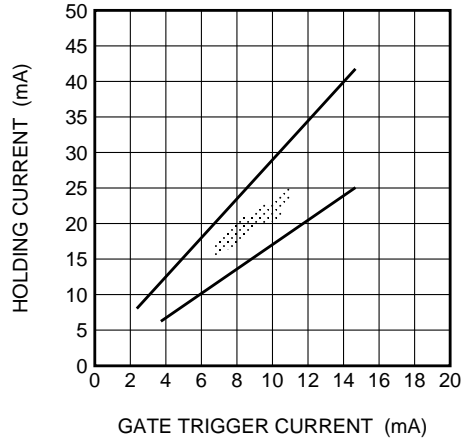

TURN-ON TIME VS. GATE CURRENT

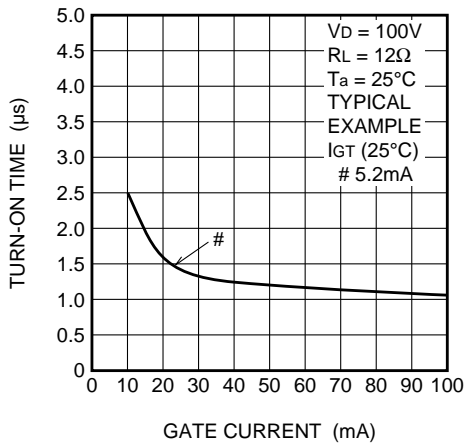

TURN-OFF TIME VS. JUNCTION TEMPERATURE

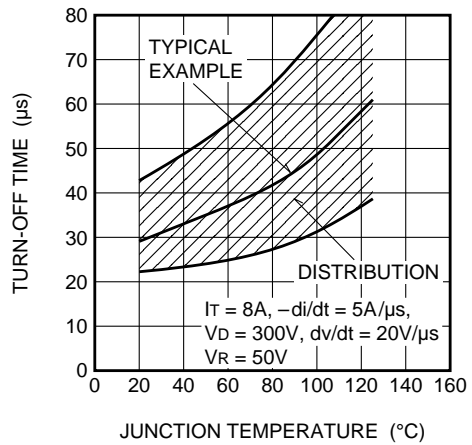

REPETITIVE PEAK REVERSE VOLTAGE VS. JUNCTION TEMPERATURE

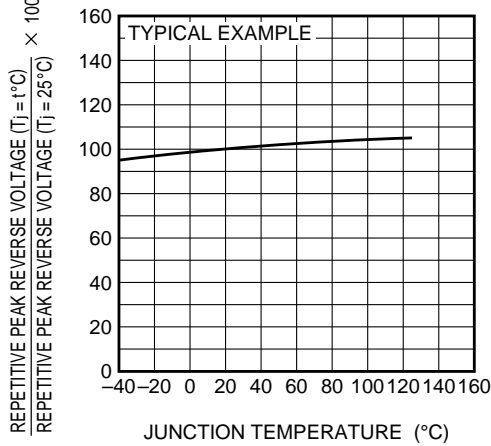

GATE TRIGGER CURRENT VS. GATE CURRENT PULSE WIDTH

